Socially Shared Enacted Imagination of Abstract Concepts

Edwin Hutchins

University of California San Diego

Yesterday, John Stewart asked,

“How can physicists imagine the first few nanoseconds after the big bang?”

“They have a theory.”

Today, Ed Hutchins asks,

“How do scientists imagine their theories?”

Example 1: imagining biochemical theory. (Amaya Becvar)

- Imagining the dynamics of the thrombomodulin molecule when it binds with thrombin.
 - A laboratory research meeting. PI introduces a theoretical construct that has been included in a grant application.
 - No one has ever seen a molecule directly.
-

“Our new theory is that thrombomodulin does something like this, or like this.”

Locating this work in the
BIG PICTURE
of cognitive science

High-level Cognitive Processes

Nervous System

GOFAI ↔ High-level Cognitive Processes



Nervous System

GOFAI ↔ High-level Cognitive Processes



PDP



Nervous System

GOFAI

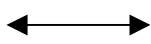

High-level Cognitive Processes



PDP



Brain
Imaging



Nervous System



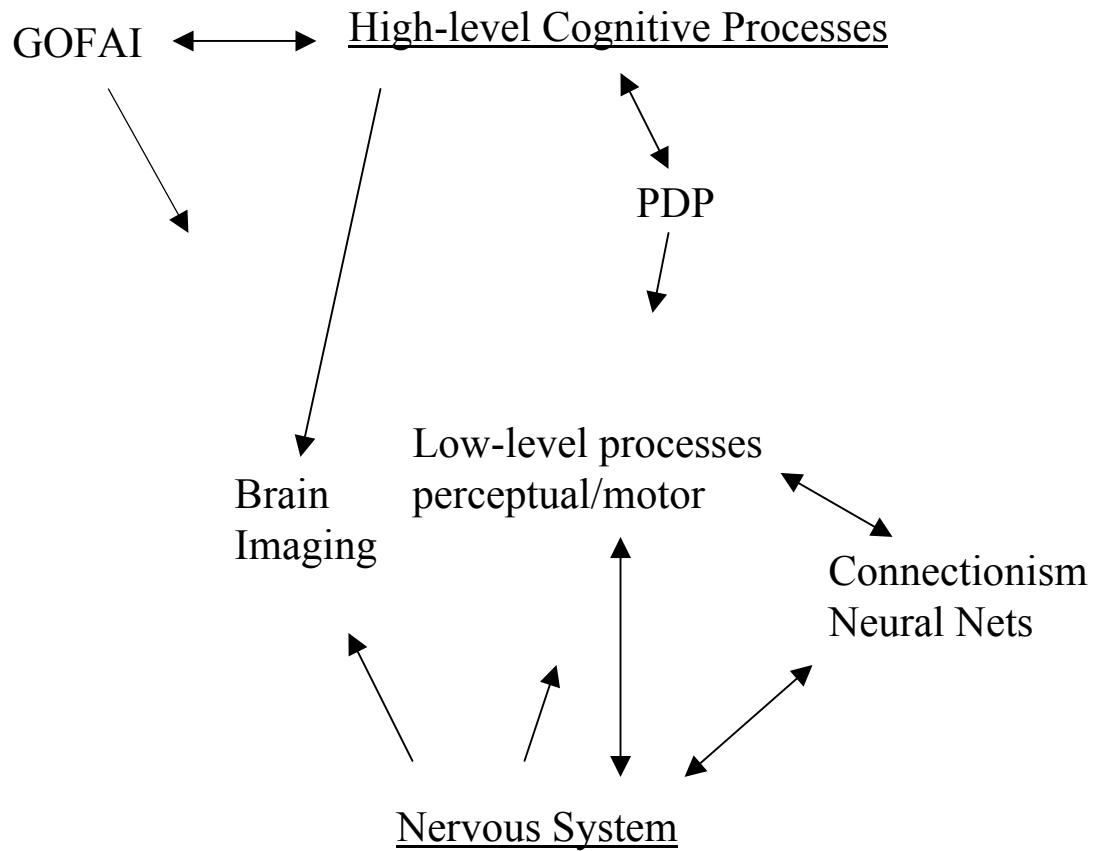

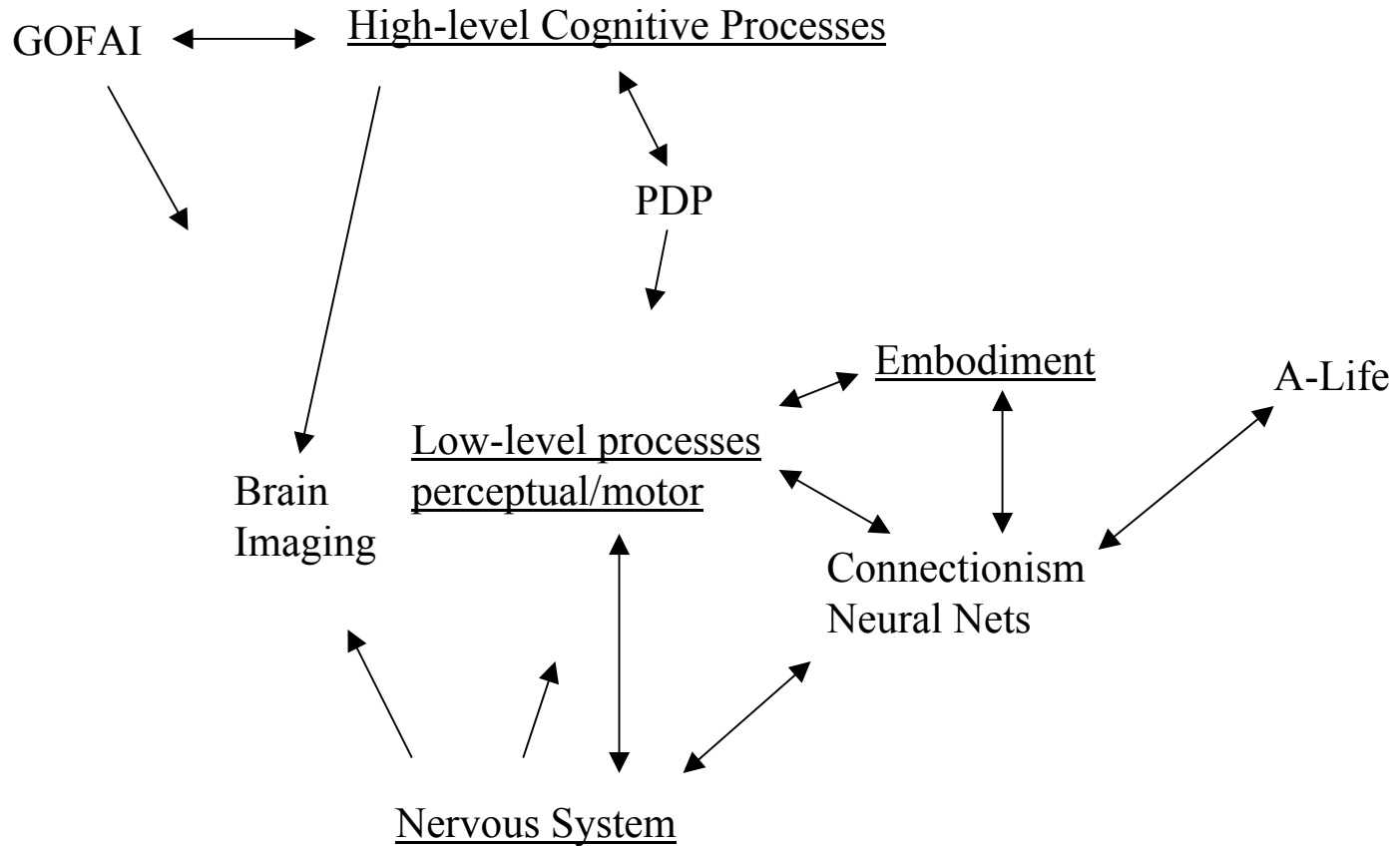

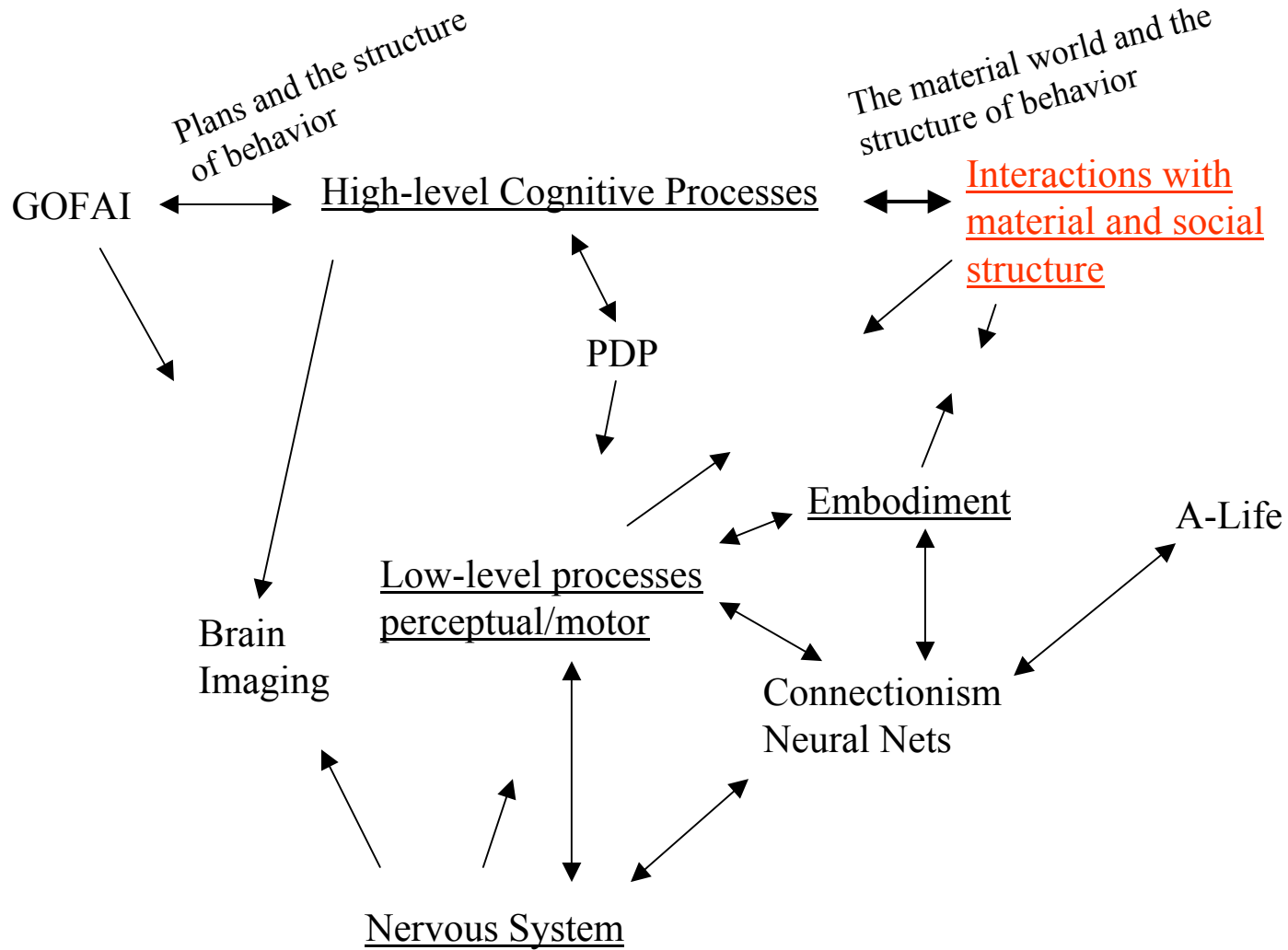

Changing patterns of information flow can change the cognitive properties of the system

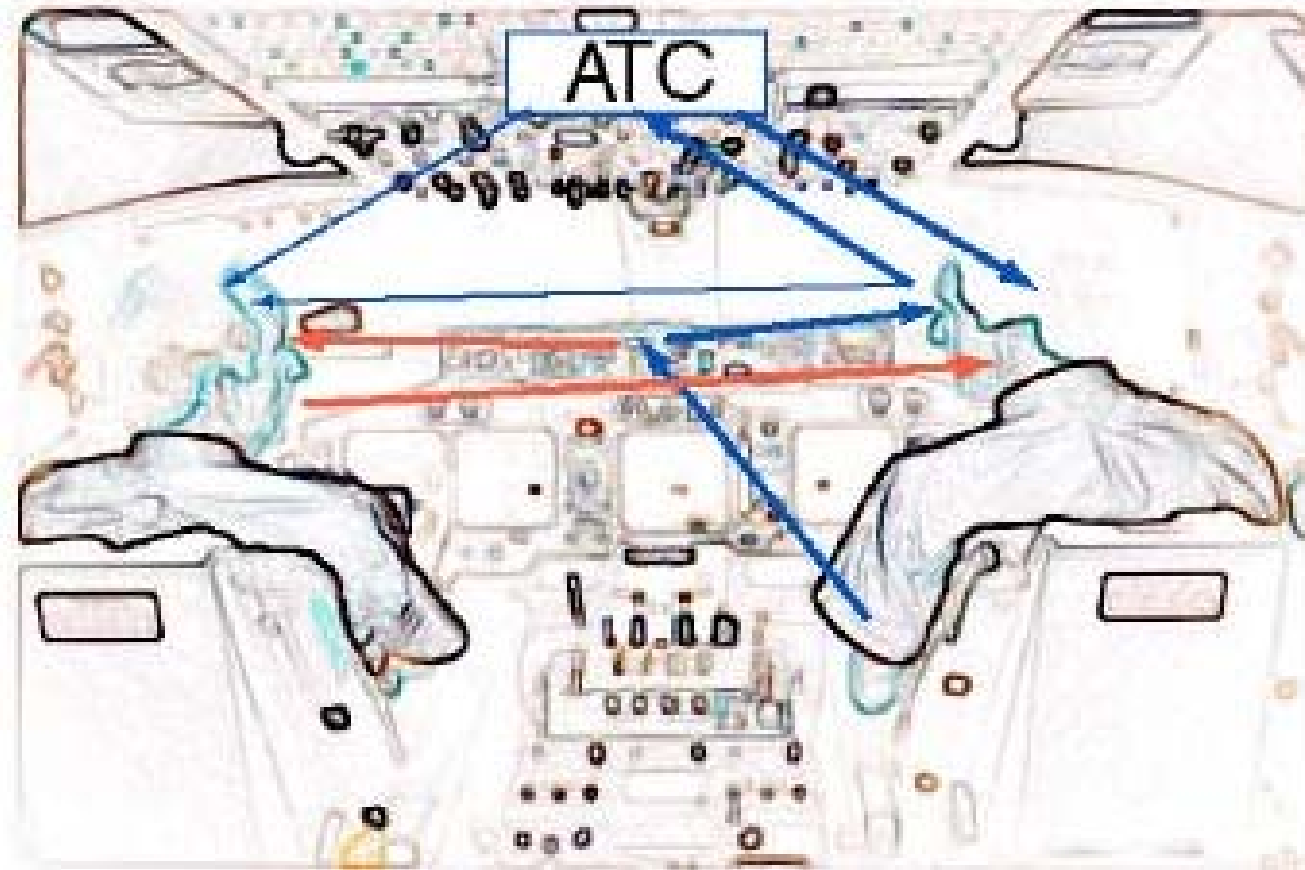

Tools can change the patterns of information flow ...

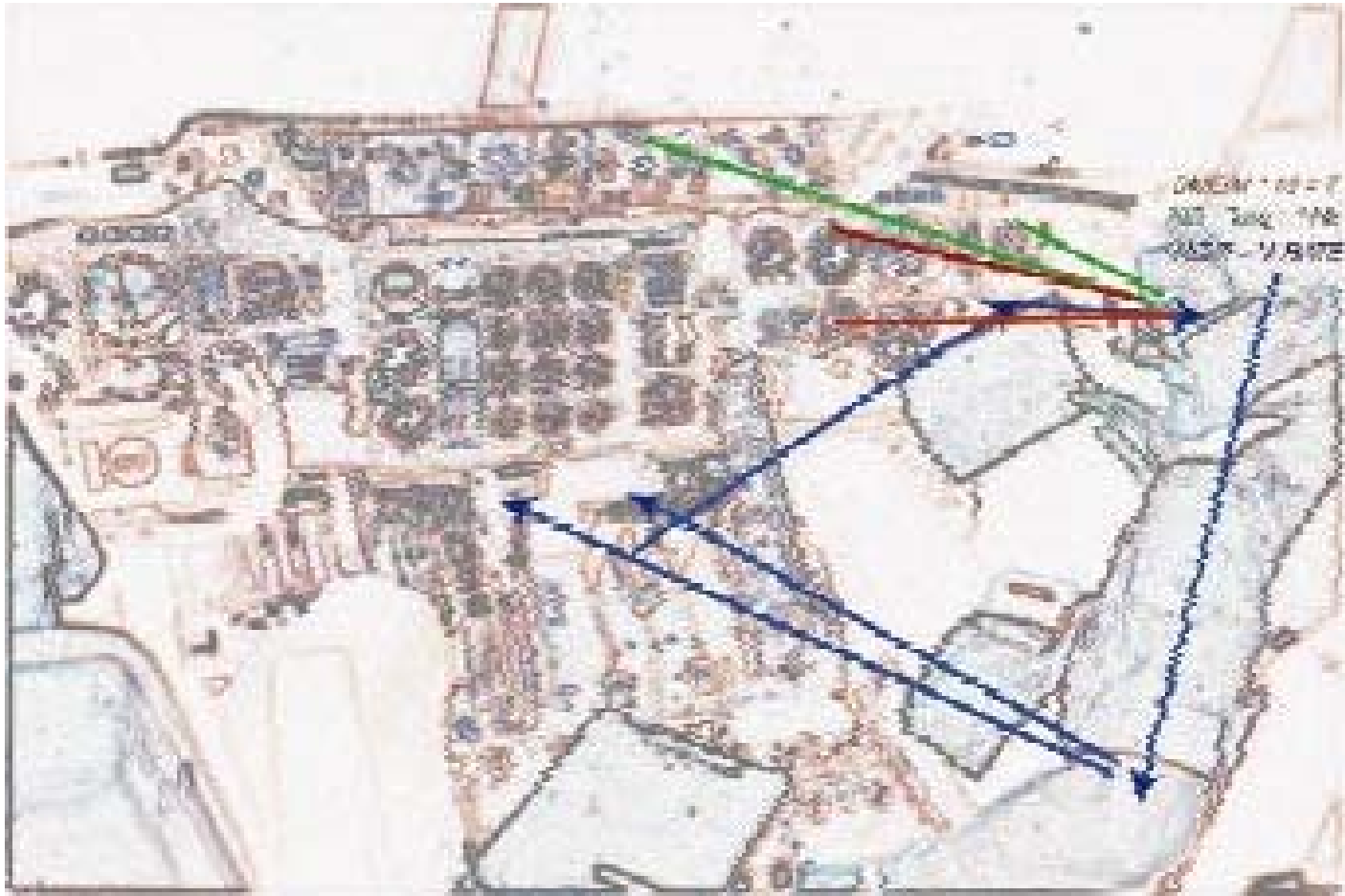

Using perceptual processes to do conceptual work: Boeing's Green Arc



...and this creates a new functional system with different cognitive properties

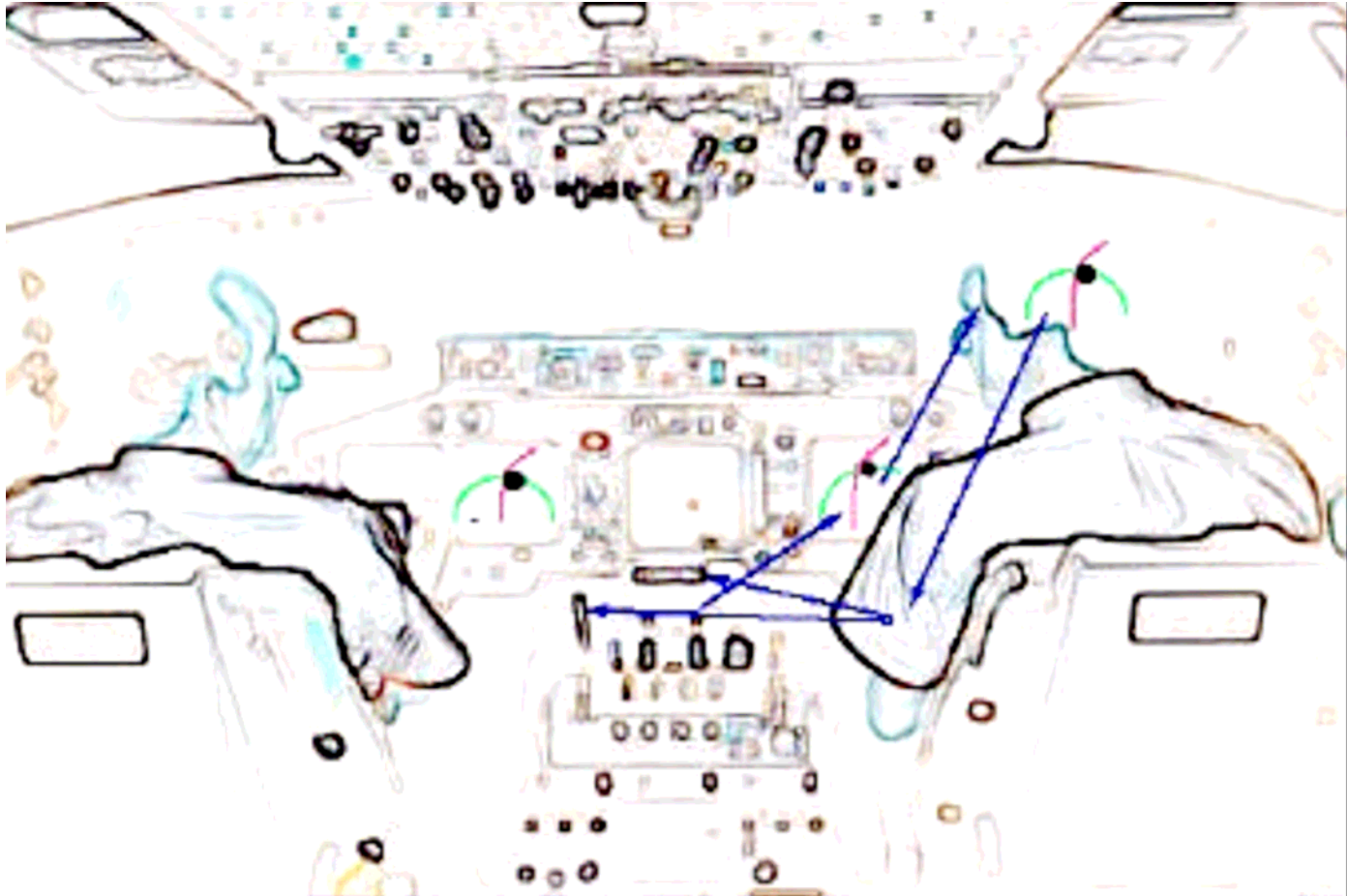

How material structure can be
used to stabilize concepts for
reasoning

Conceptual blending

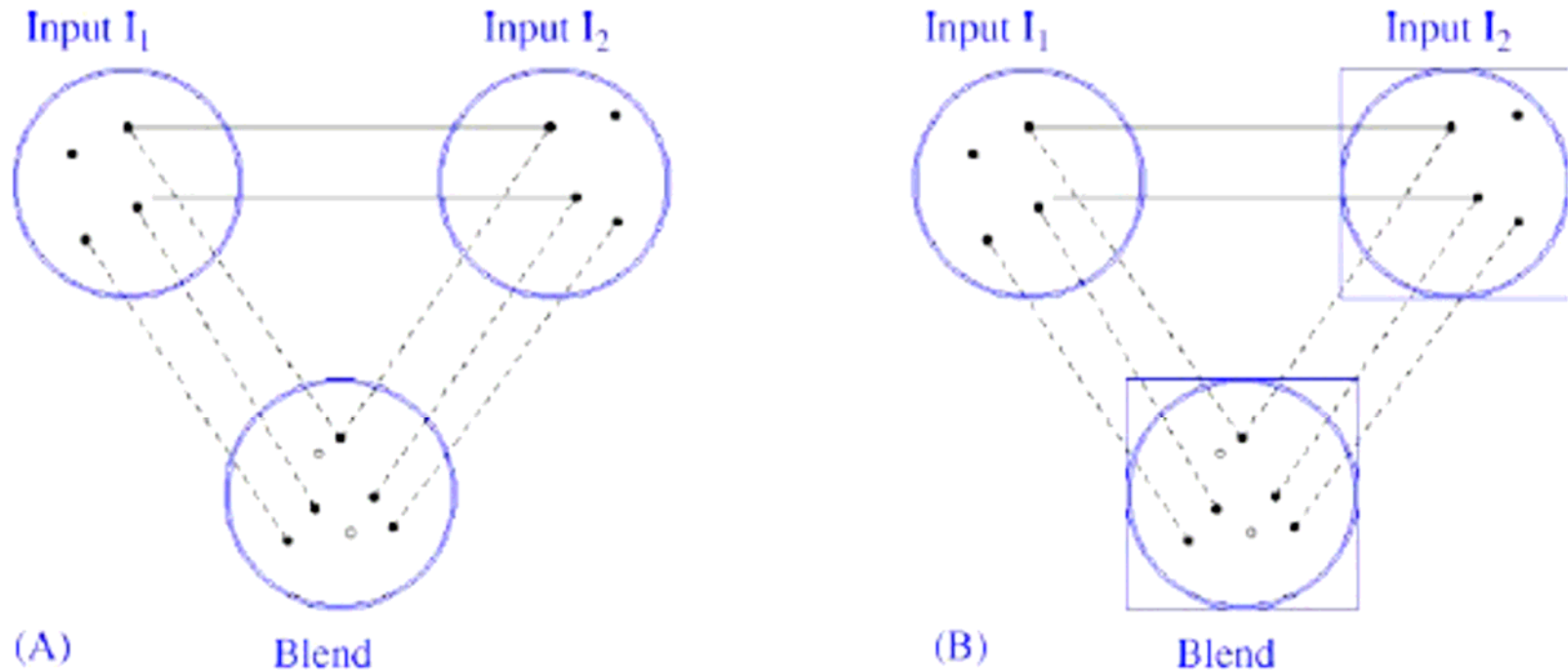
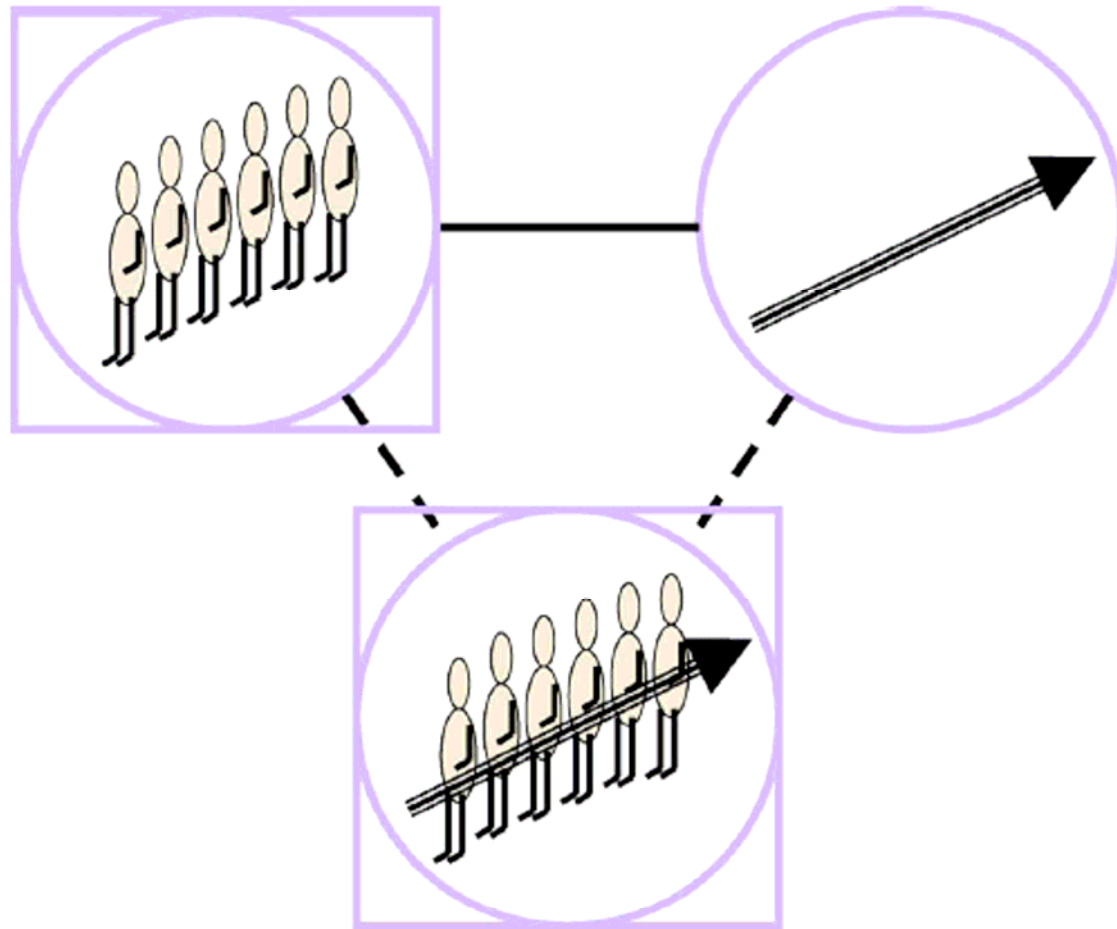
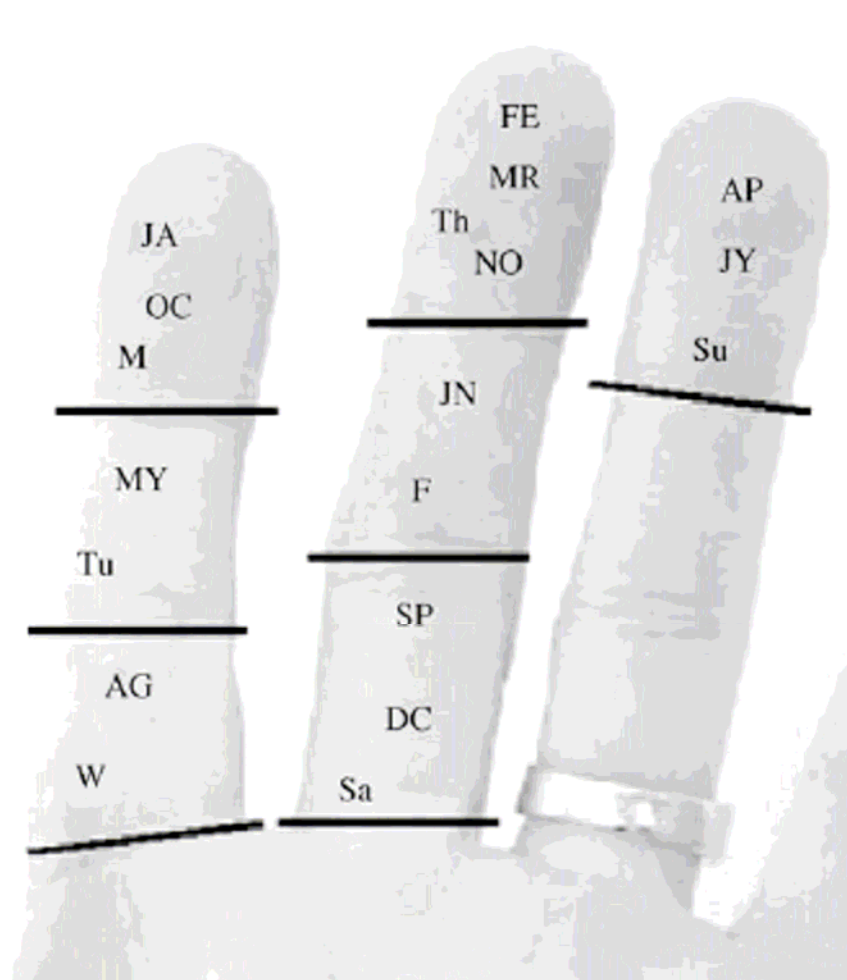

Fig. 1. A conventional conceptual blend (A), and a conceptual blend with a material anchor (B).

Forming a queue for service – imagining a trajectory in space and time



Japanese Hand Calendar – imagining the coordinated cycles of days and months



Medieval tide computer – imagining temporal landmarks on the compass rose

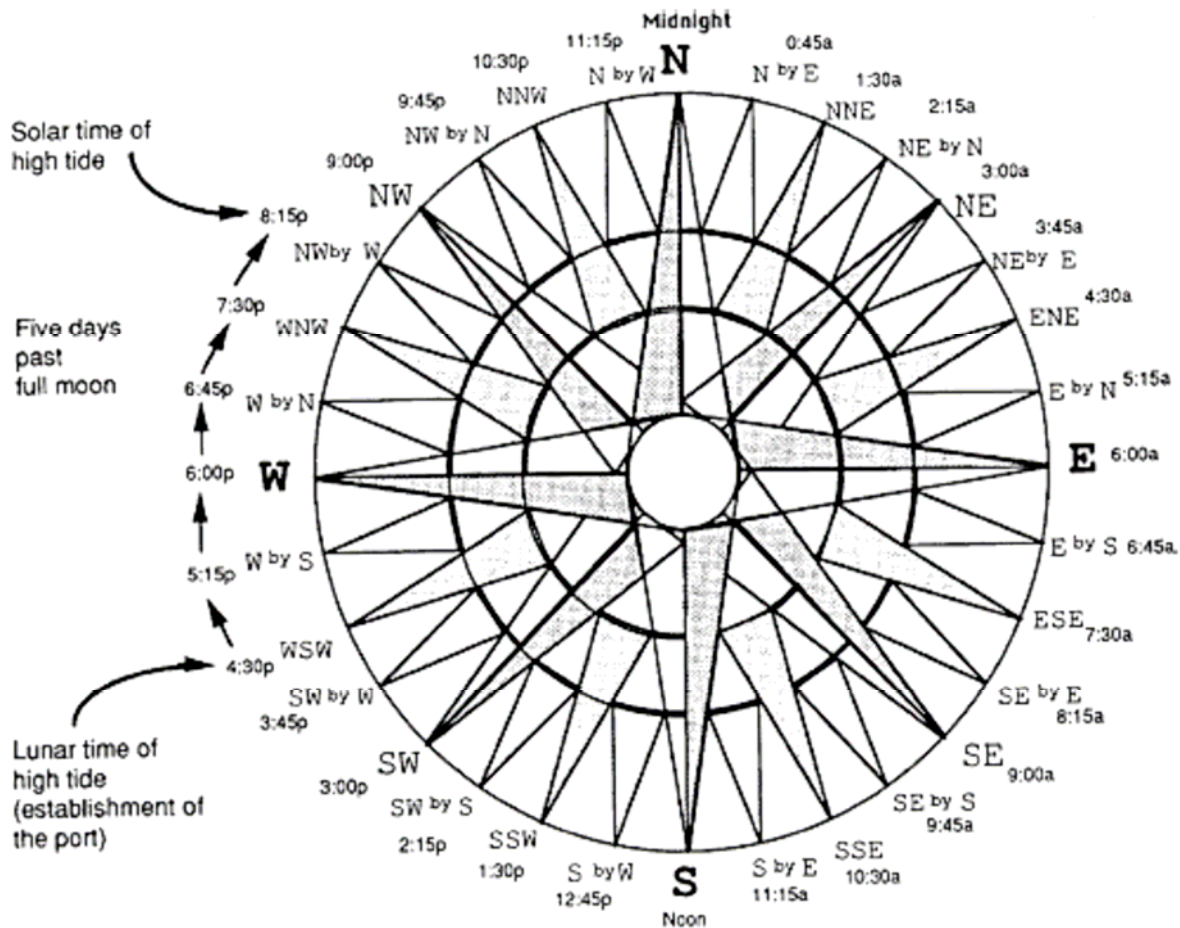

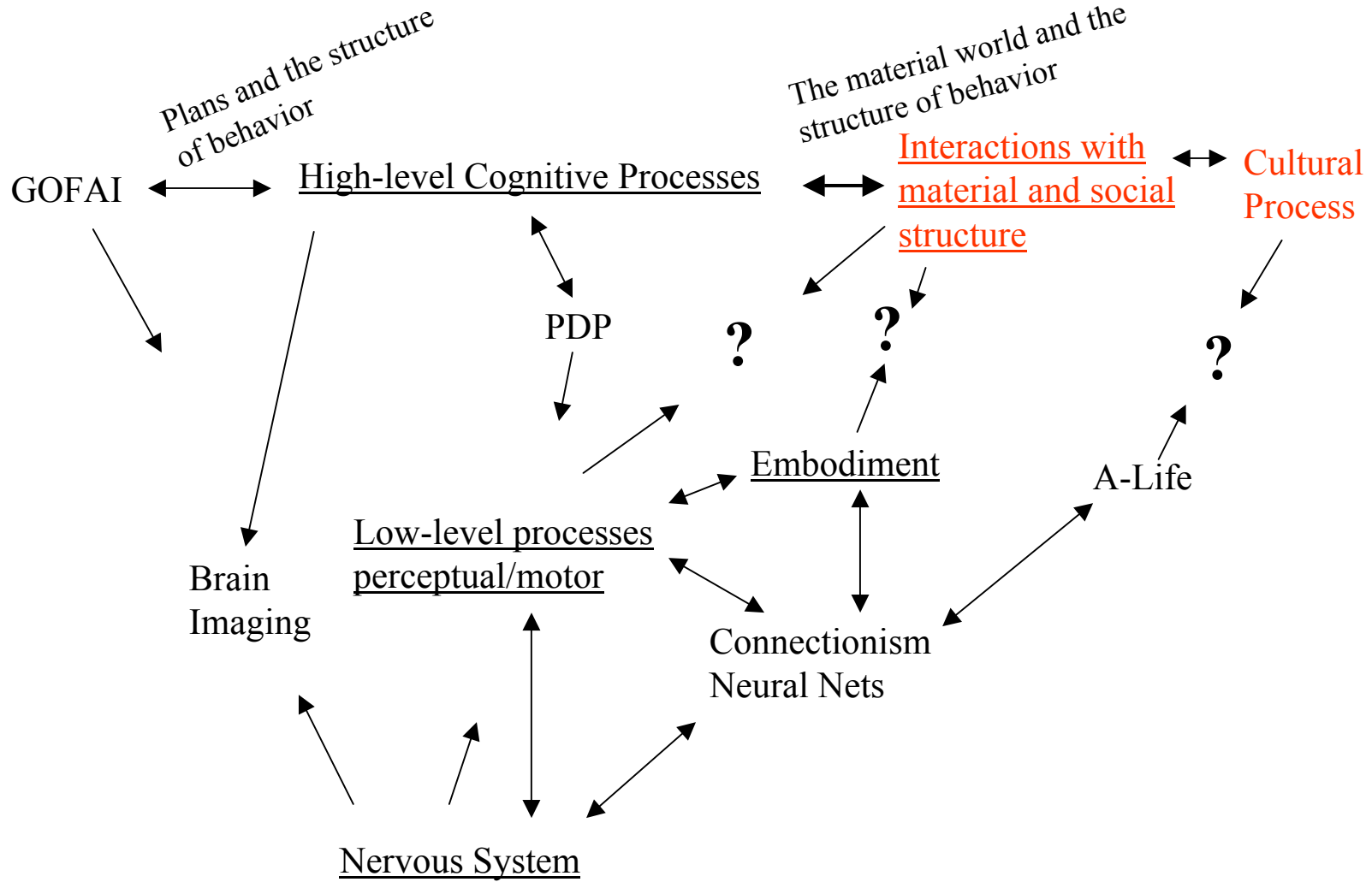

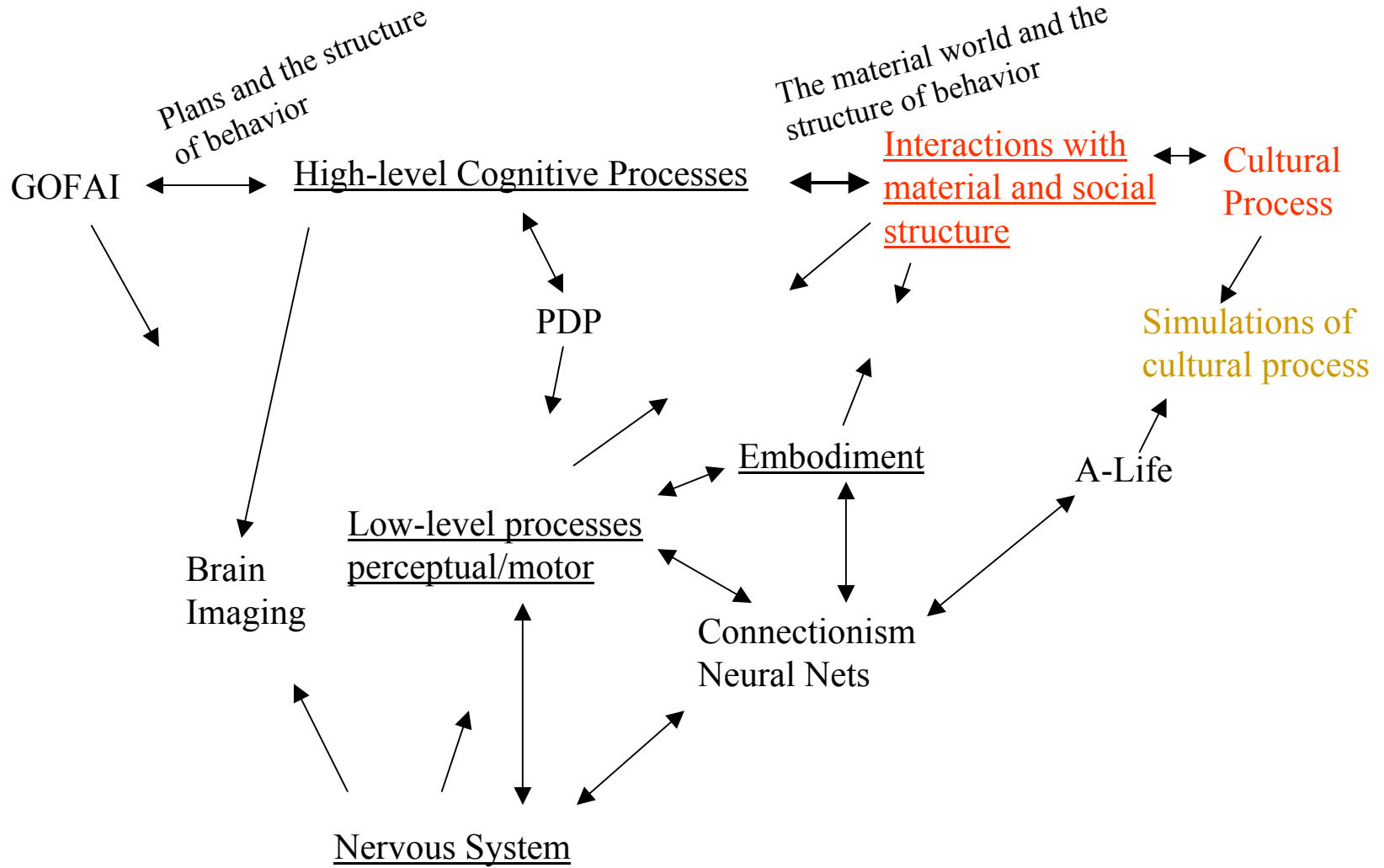

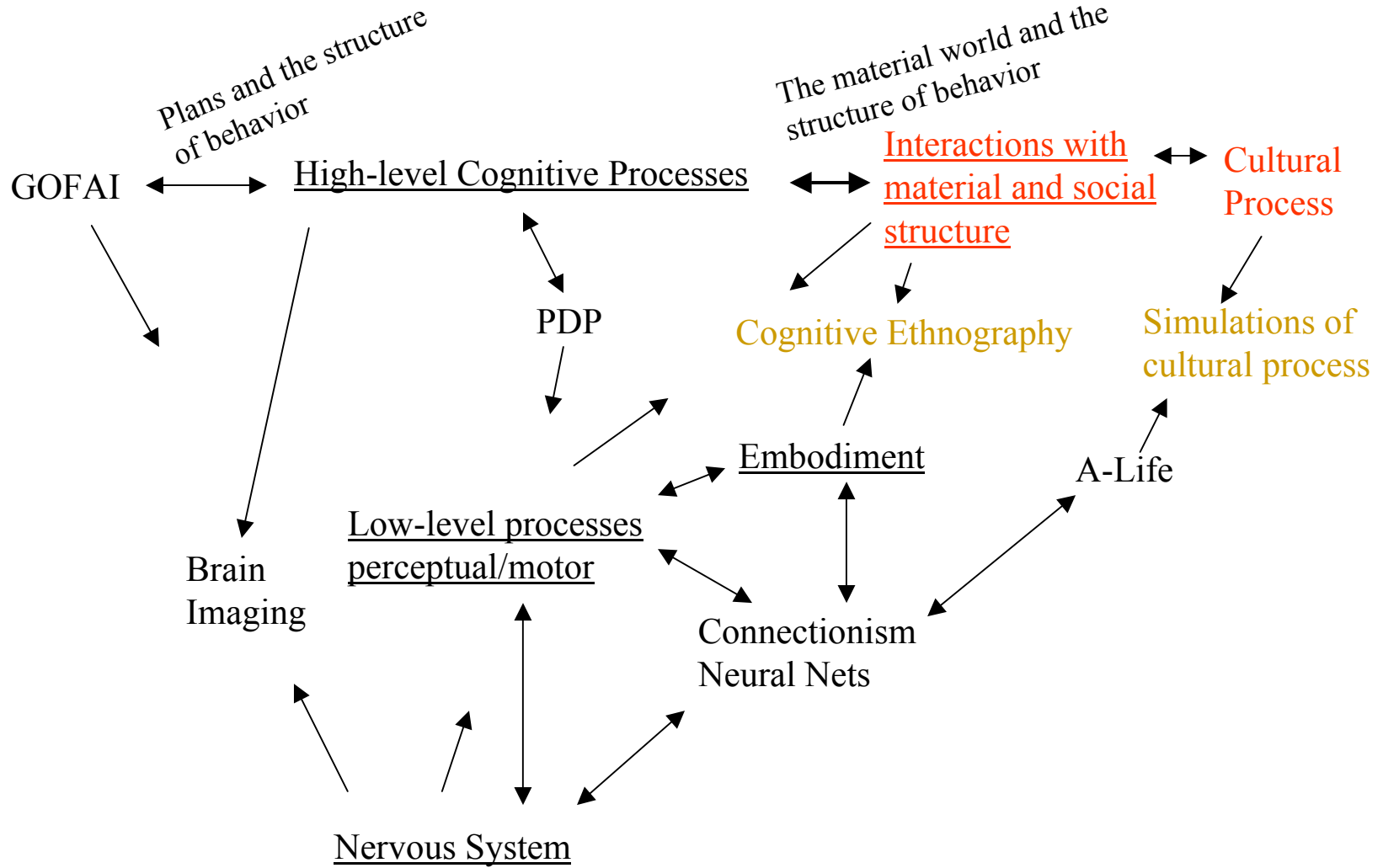

Trobriand Island land litigation



Real world language is richly multimodal

Lexicon

Syntax

Talk

Rhetoric

Prosody

What is lost when cognitive theory ignores the body?

Video recordings highlight a new unit of analysis
(Triangle of embodied communication)

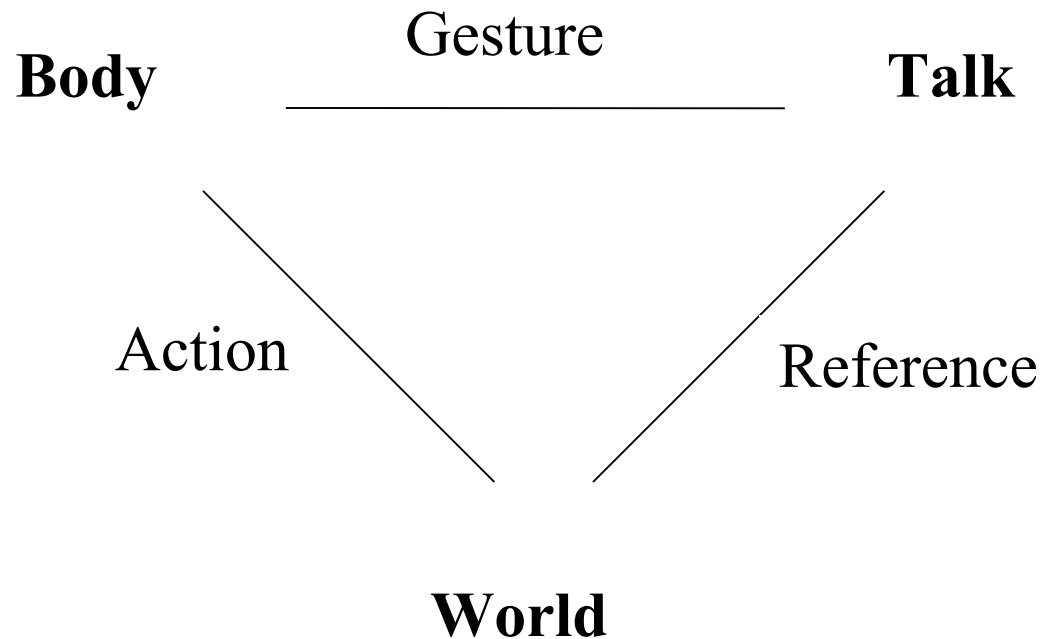

Imagining a fictional process

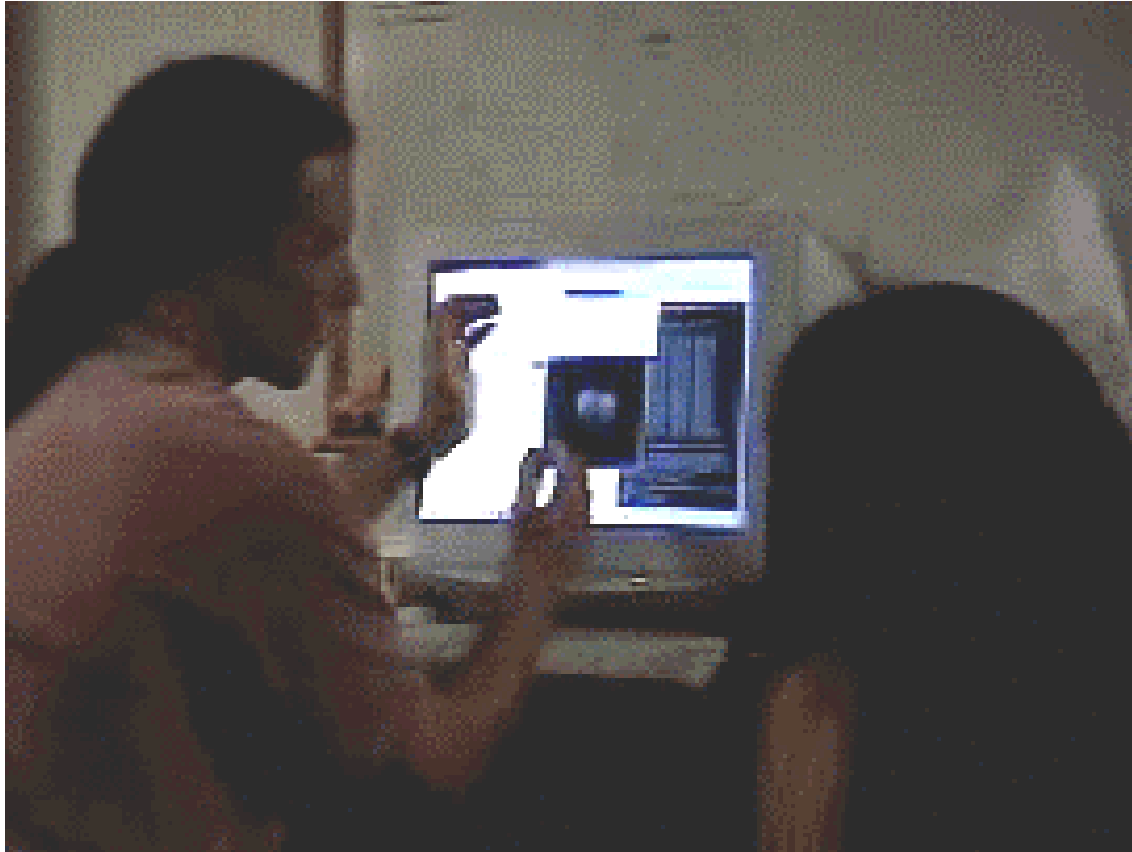

It's sort of... [gesture]

It's sort of ... it's actually sheared

Imagining molecular dynamics

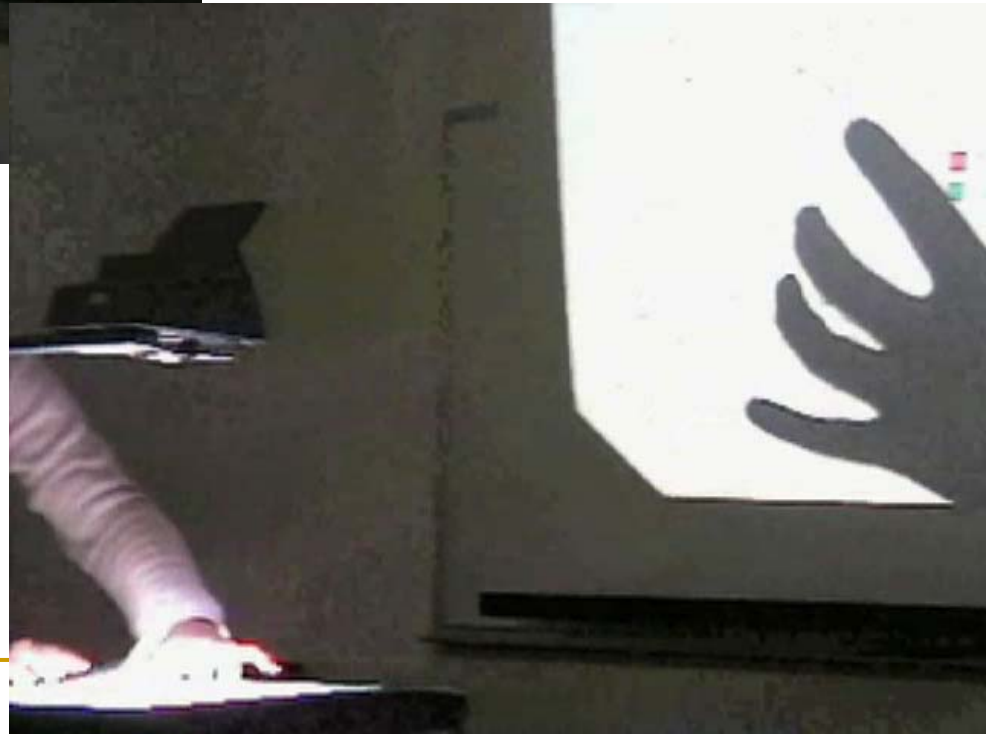

Image and research by Amaya Becvar





Thrombomodulin does something like this [] or like this [].

Imagining scientific abstractions (Triangle of embodied communication)

Gesture expresses concepts that are difficult to capture in language:
spatial relations, dynamics

Body

Talk

Environmentally coupled gestures get their meaning from their relation to culturally meaningful material stuff

Reference

World

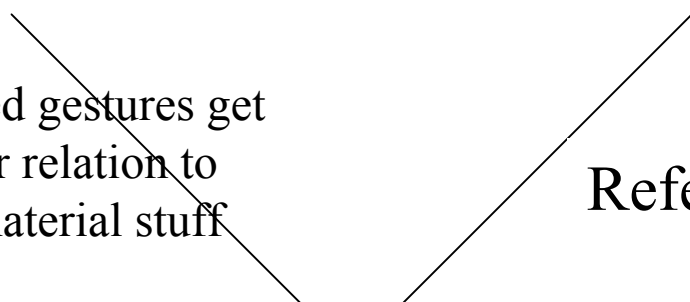

Imagining the present and the future



Images and research by Edwin Hutchins

Navy Ship



Ship's Navigation Team



Position Fixing by Visual Bearings

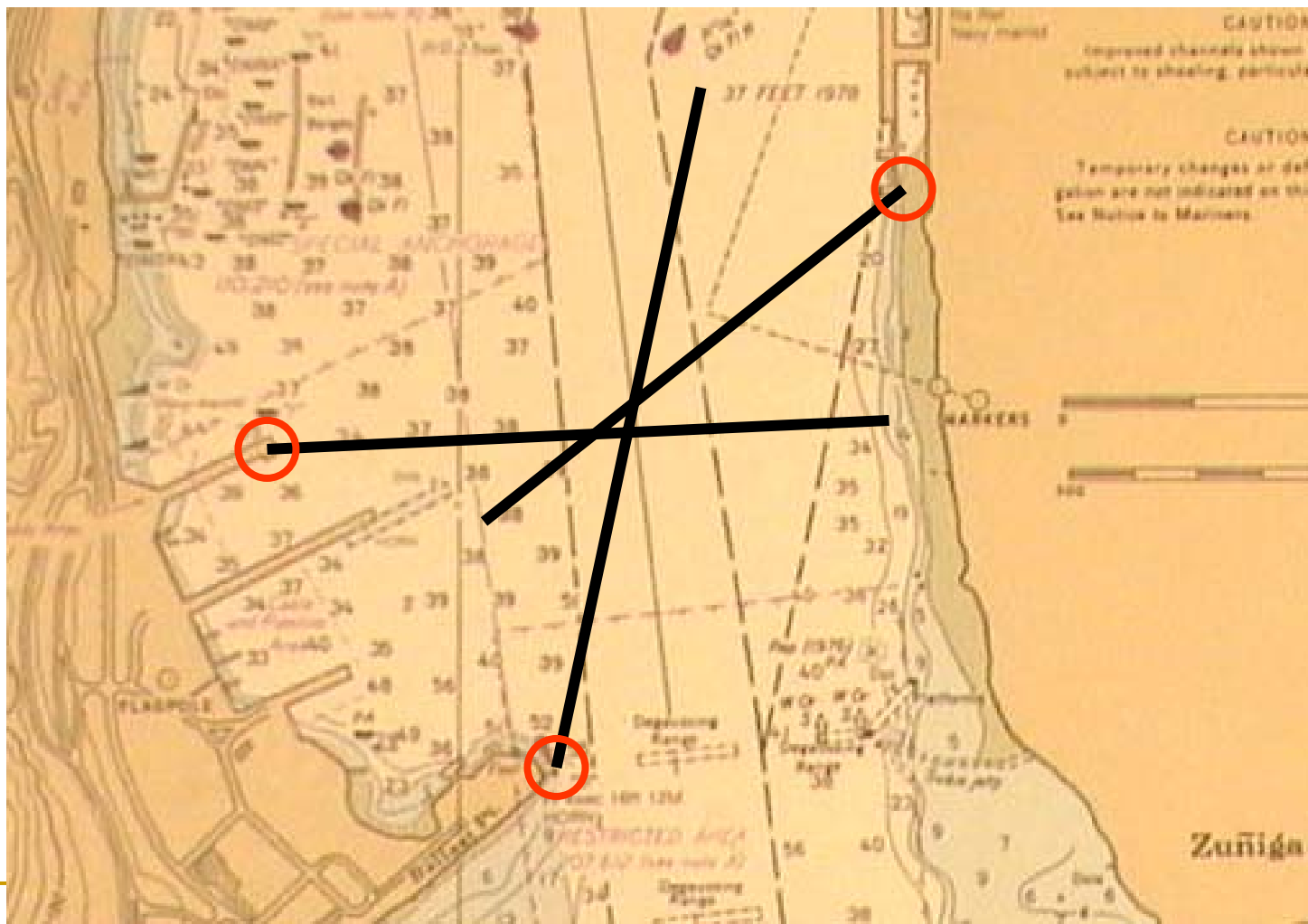

Hoey in Coordination with the Chart

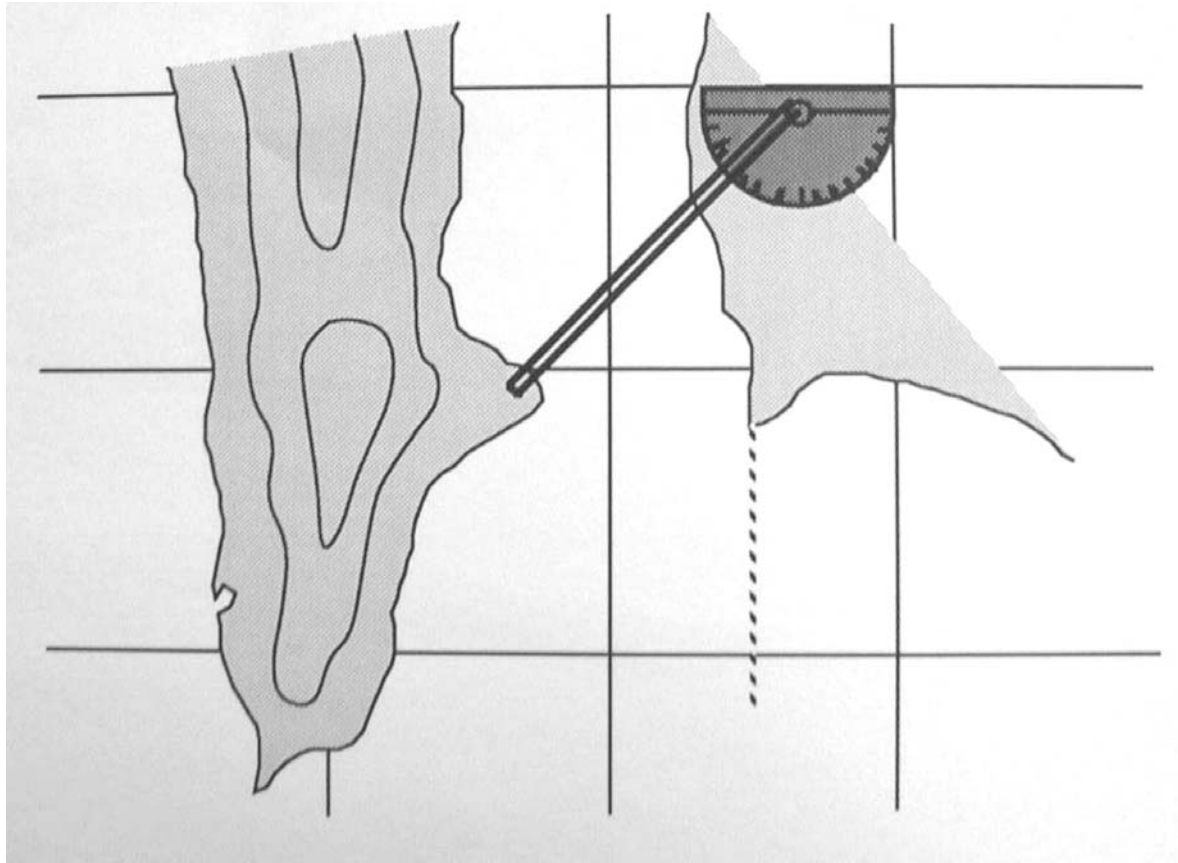

Enacting LOPs in Gesture



Integration and mutual elaboration of multiple modalities

Visual Imagery

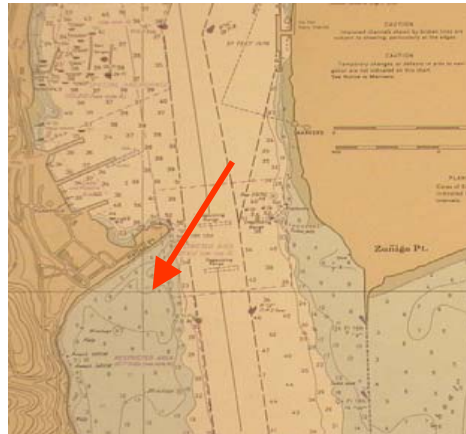

Motor Imagery

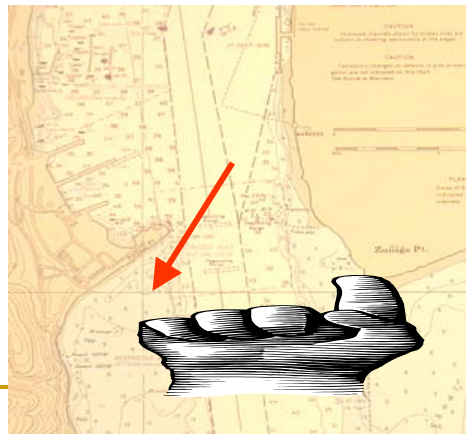

“It’ll be **that** and that”

Emergency Situation: loss of fuel flow to main steam boiler

■ Ship Control

- ❑ Loss of propulsion - can't stop
- ❑ Decreased steering response
- ❑ Loss of electrical power throughout the ship

■ Navigation

- ❑ Loss of main gyrocompass system
 - ❑ Loss of ability to directly measure true bearings of landmarks
 - ❑ Need to compute True Bearings from Relative Bearings
-

Corrections to be applied

$$TBLm = ((C+D)+V)+RB$$

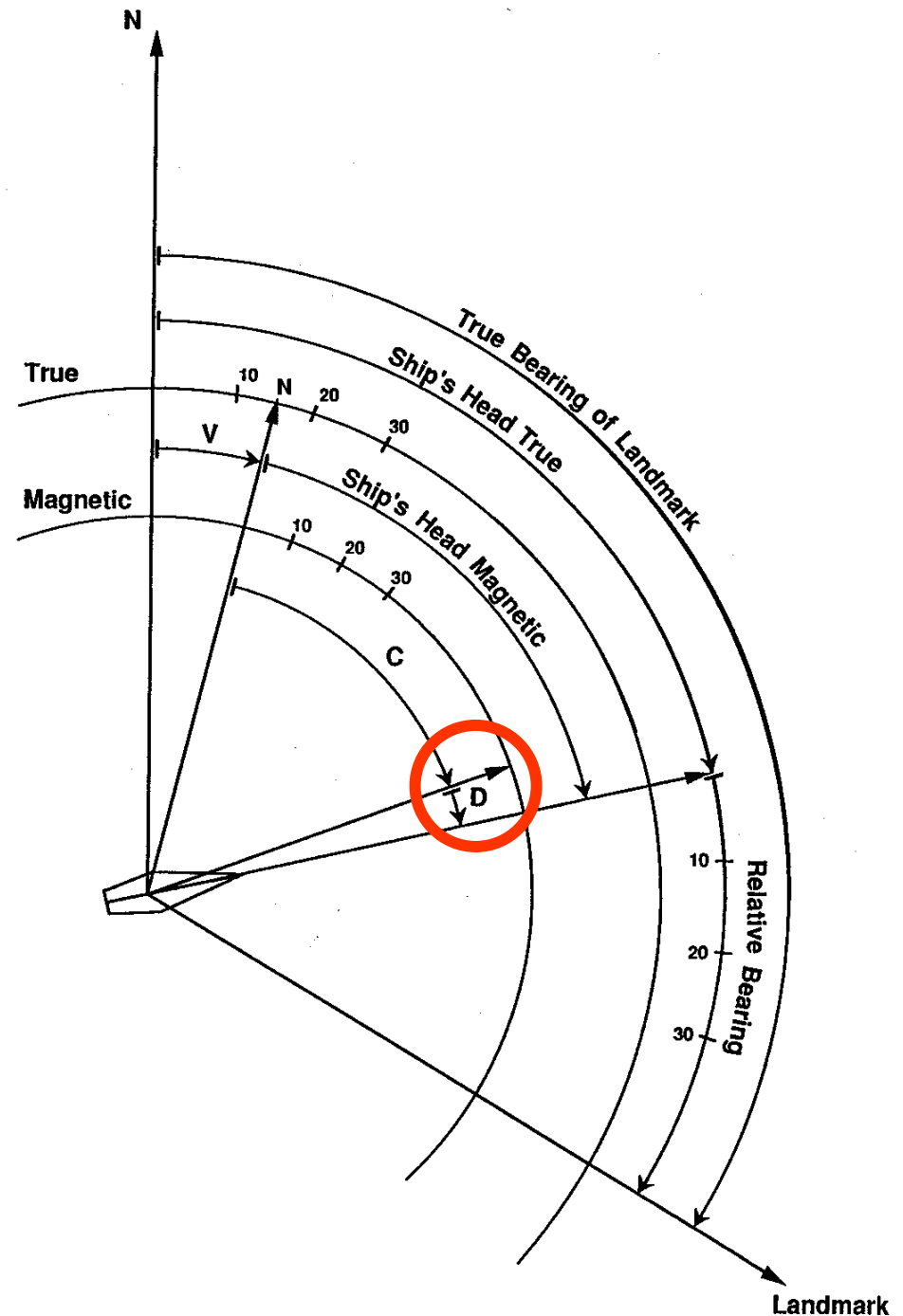

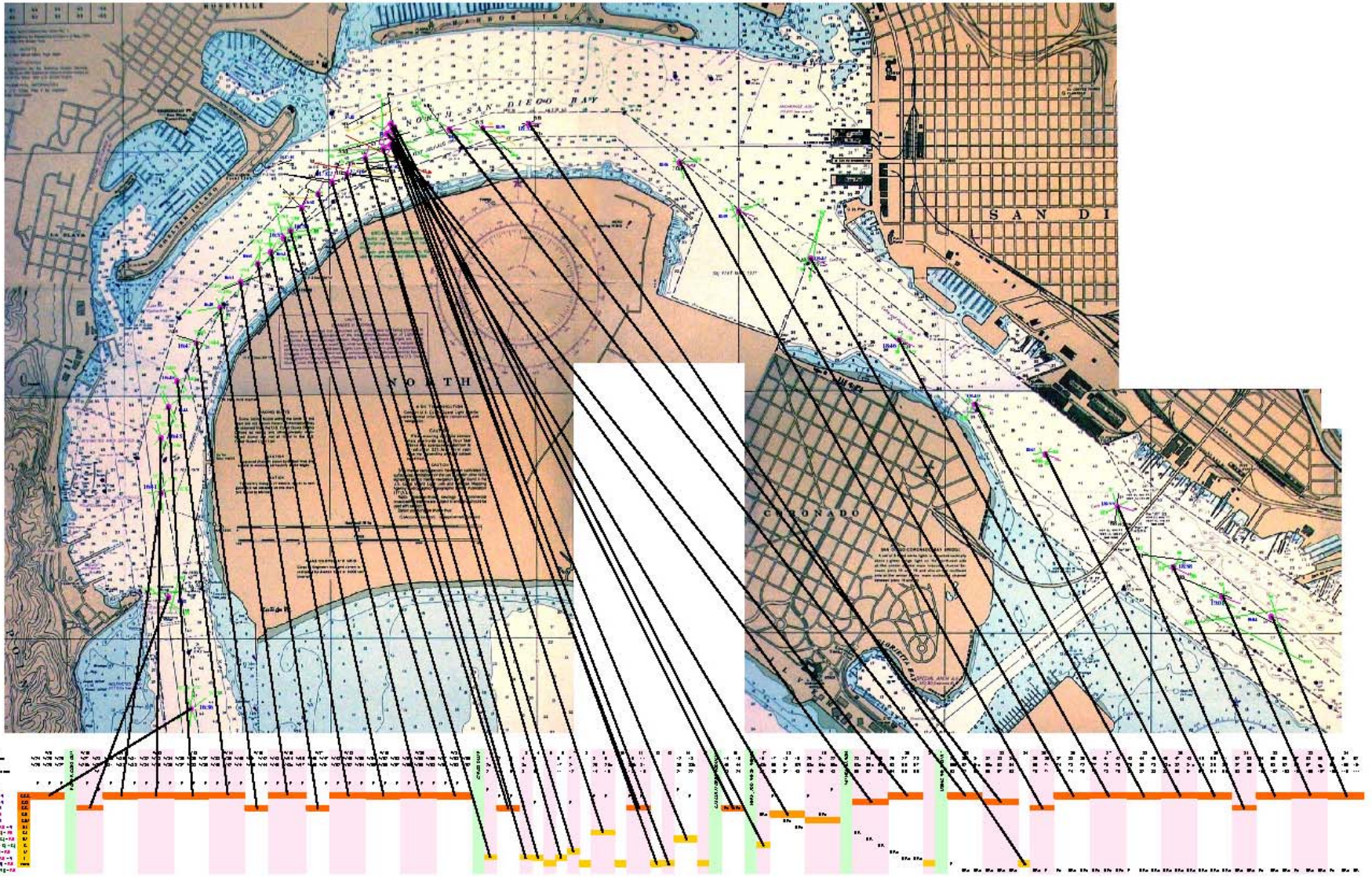

Discovery of missing
Deviation term

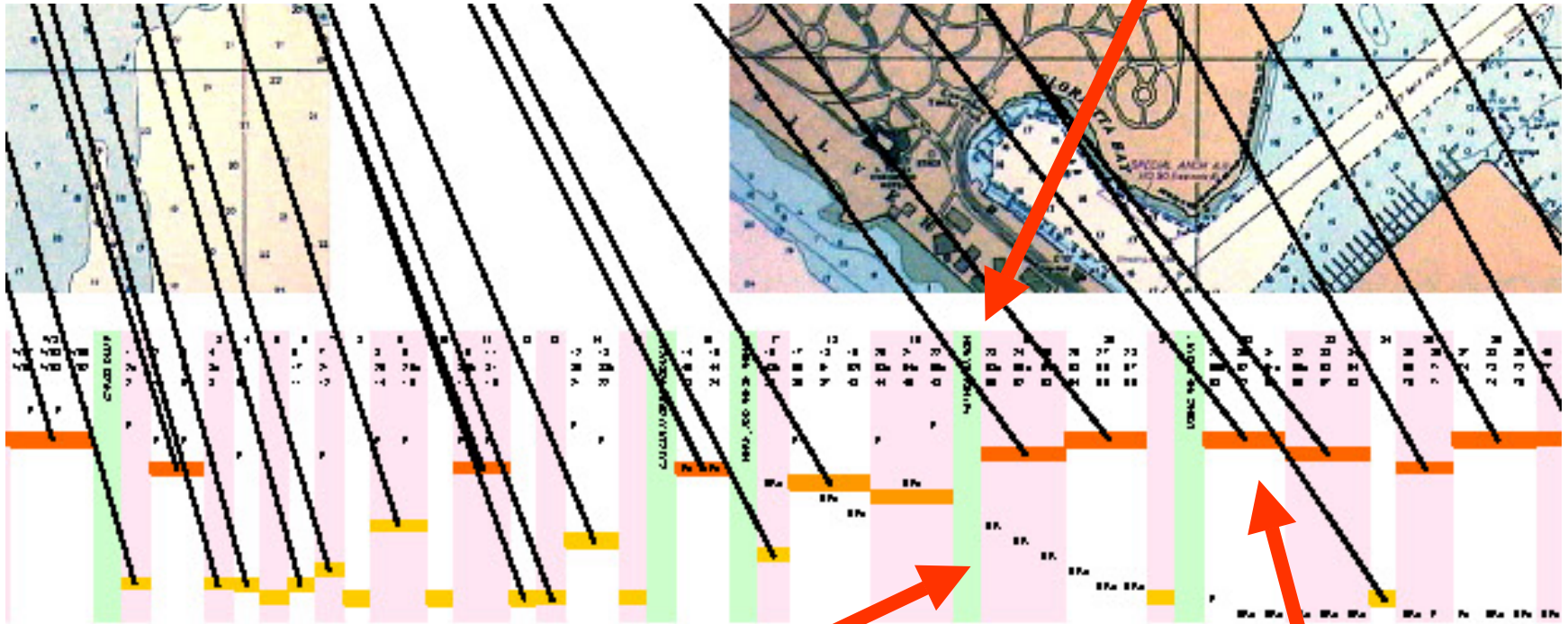

Rapid changes in
Computational sequence

Recovery of fix
quality

Transcript of the moment of discovery

Chief see I keep getting these monstrous (1)

BR hm[m?

Chief [god-damn (1) these monstrous friggin god-damn triangles (1.5)

Chief tryin to figure **which** one (1) is fucking **off** (4)

BR get another round? (1)

Chief **no** no no (.5) uh uh (1.5)

Chief one two zero (2.5)

Chief I know what he's doing (2)

BR what is it (.5)

Chief lemme try (1) lemme try (.5) lemme try with my **new** ones
say **three** (.5) say **three** add **three** to everything (2.5)

BR add **three**?

BR (see if we see magnetic) ?? (4)

Chief on southwest heading add three (1)

The moment of discovery



Aha! Insight



Symbol systems don't hold the answer

- Talk leading up to the insight expresses frustration at the poor quality of the fix. “I keep getting these monstrous frigging god-damn triangles and I'm trying to figure out which one is fucking off.”
 - Computational sequences leading up to the insight simply lack the missing deviation term.
-

The unacceptably large fix triangle

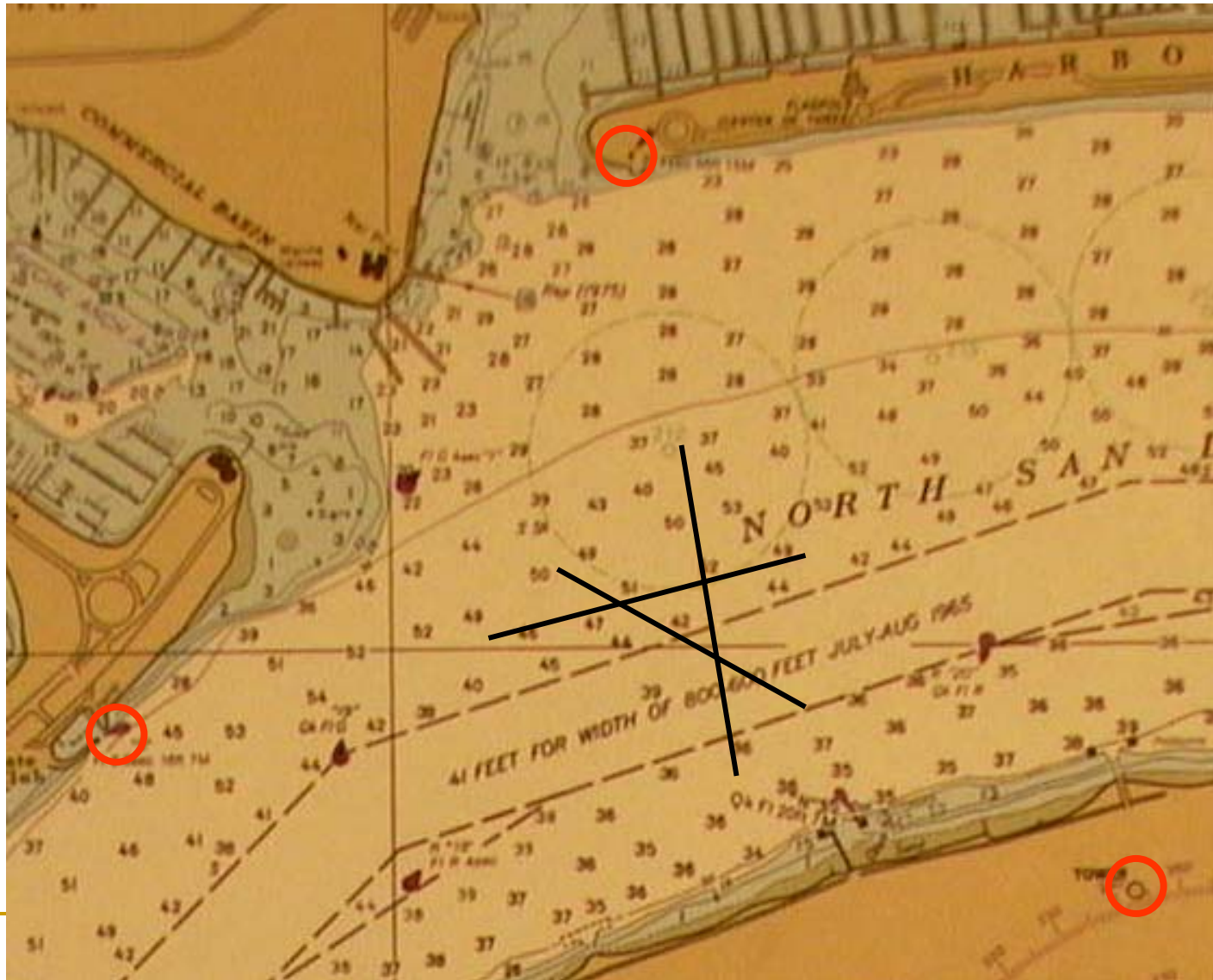

Imagining an LOP for LM1 that shrinks the triangle



Imagining an LOP that will reduce the size of the triangle

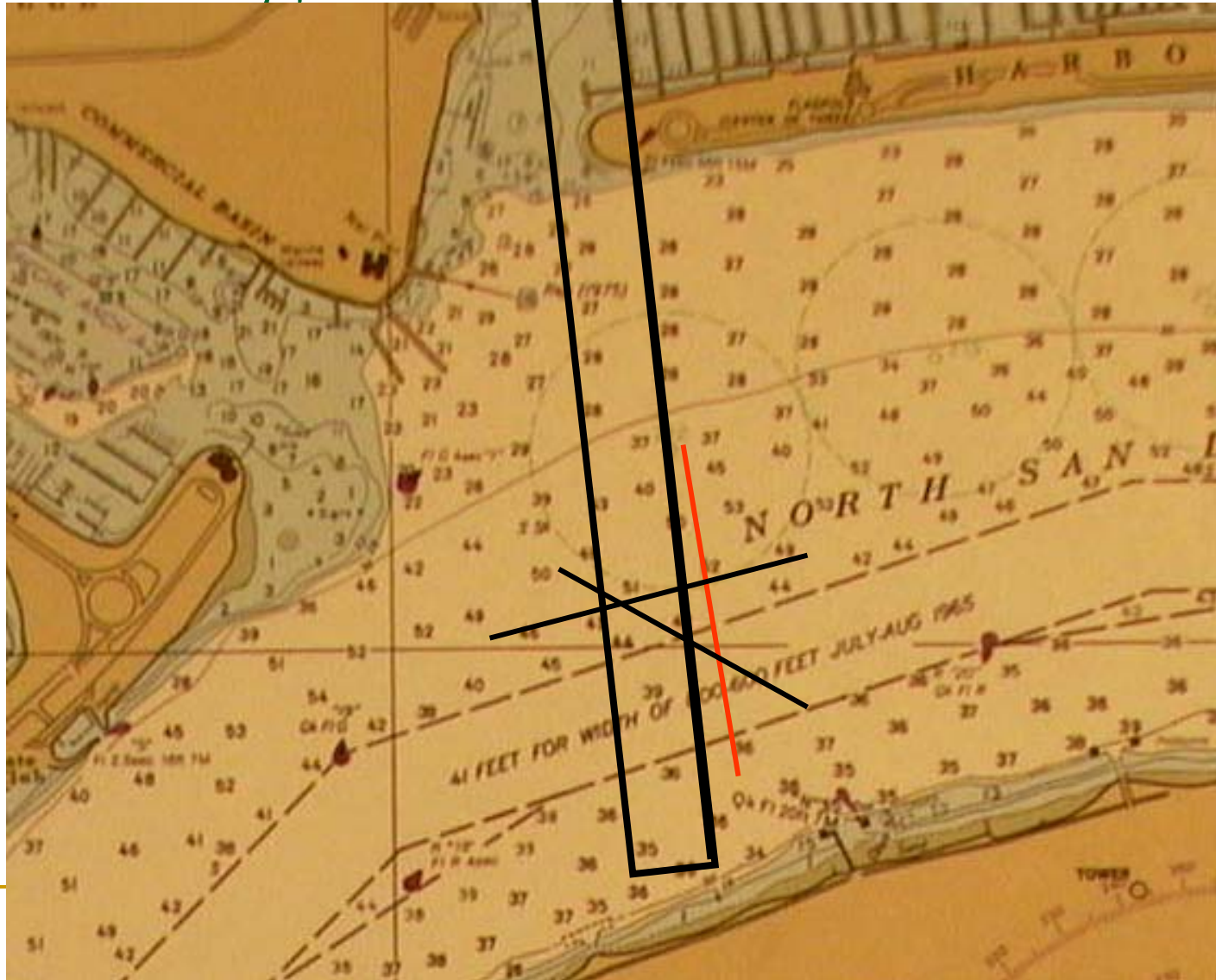

The embodied experience of imagining the first LOP

Tool motion
and visual Imagery

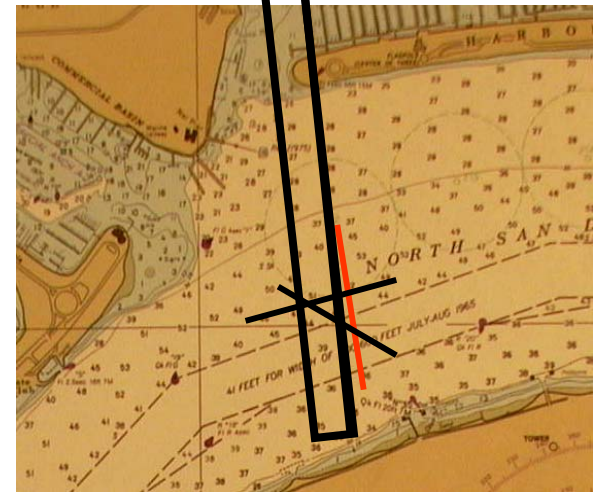
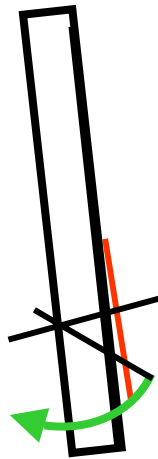

Motor
Imagery



Imagining an LOP for LM2 that shrinks the triangle



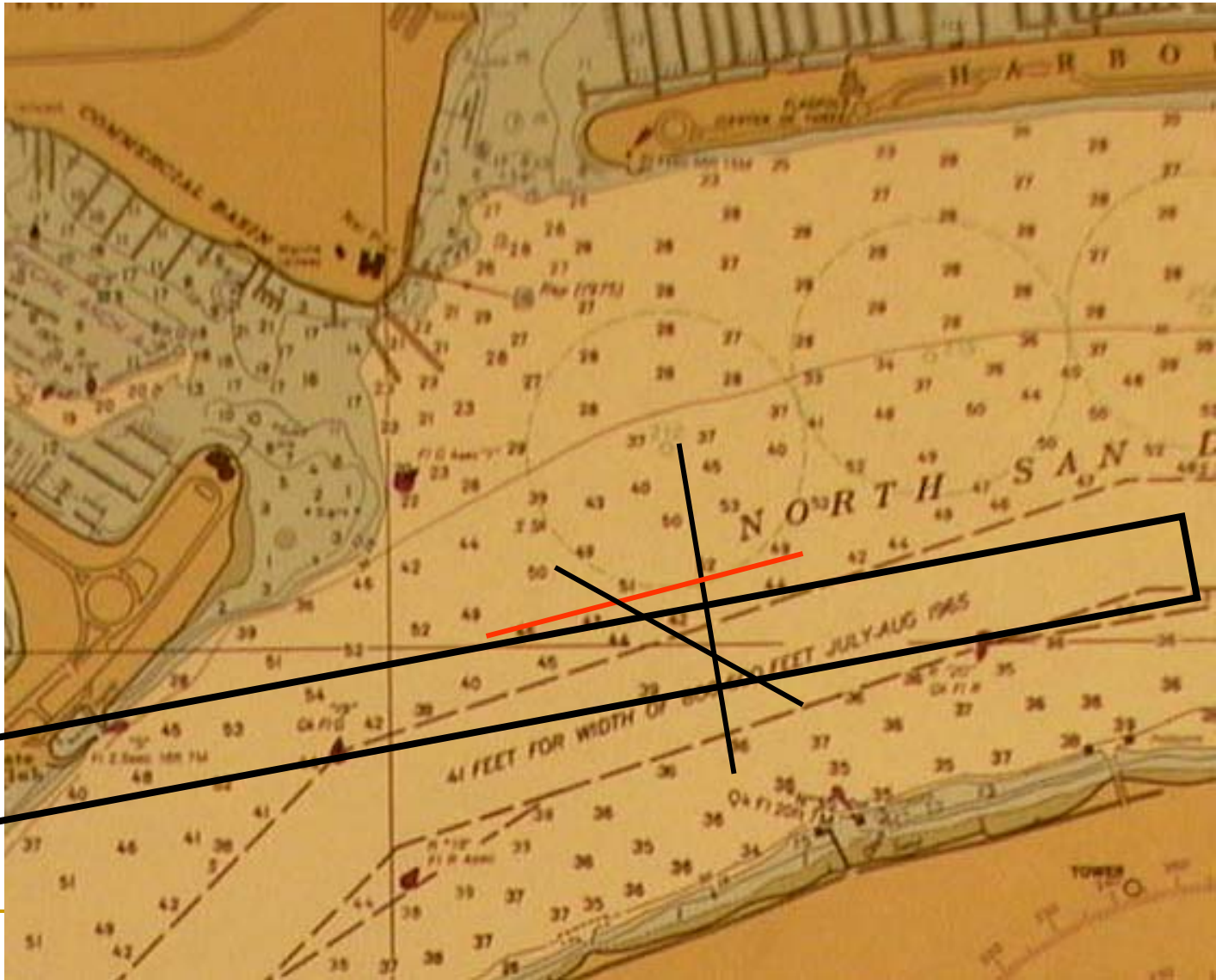

The embodied experience of imagining the second LOP

Tool motion
and visual Imagery

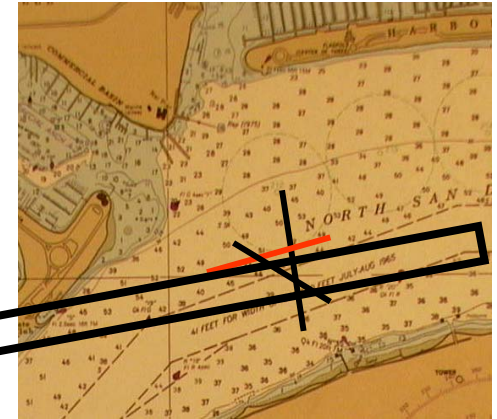
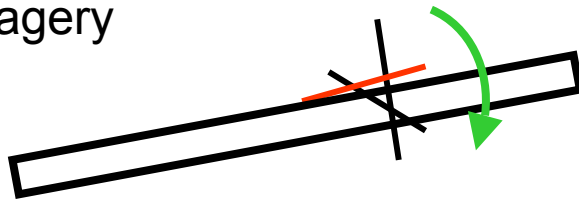

Motor
Imagery



Imagining 120° bearing to tower with a rotation to shrink the triangle

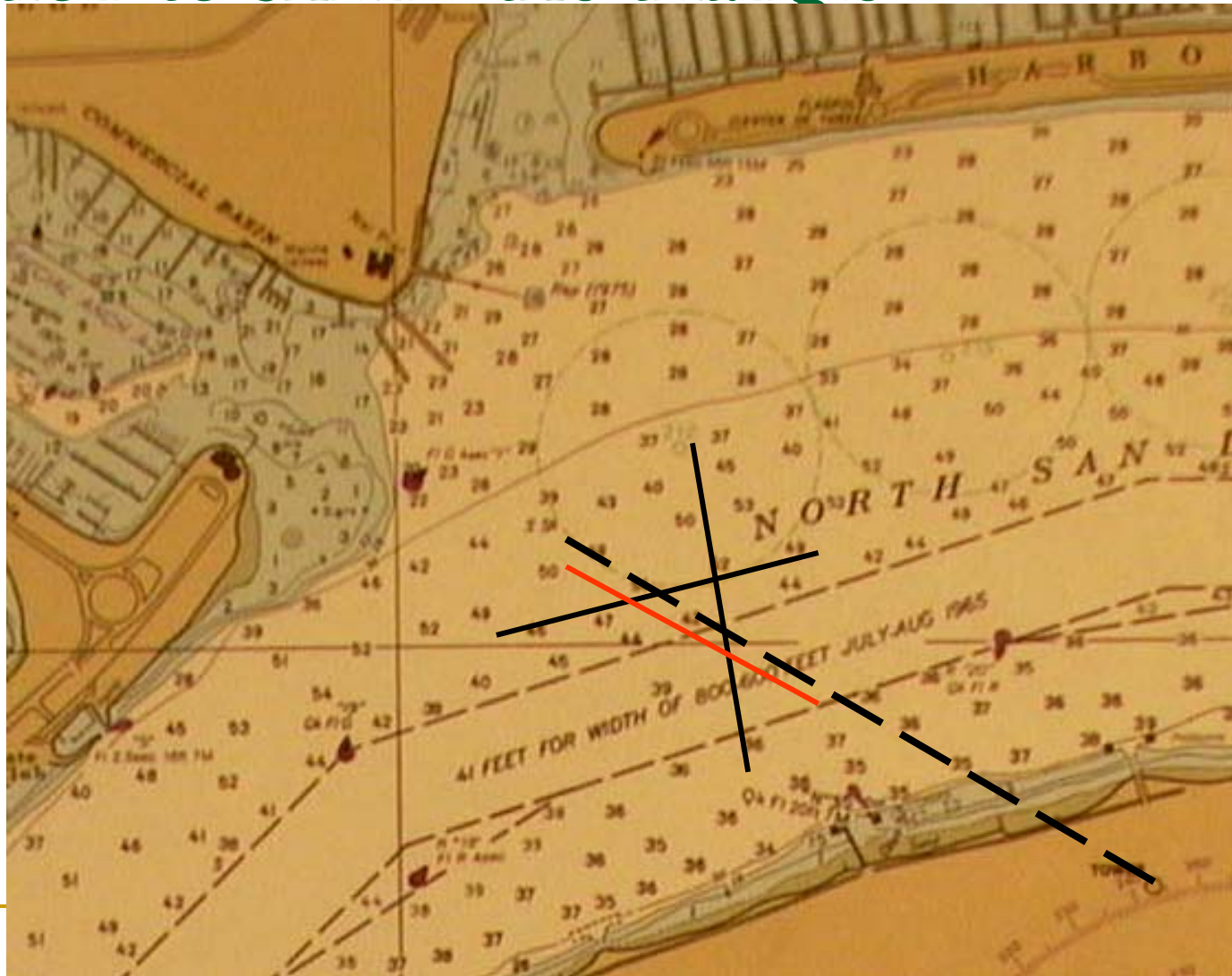

The embodied experience of imagining the third LOP

Visual Imagery

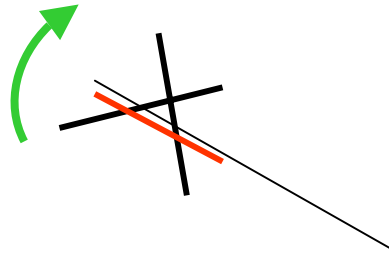

Motor Imagery

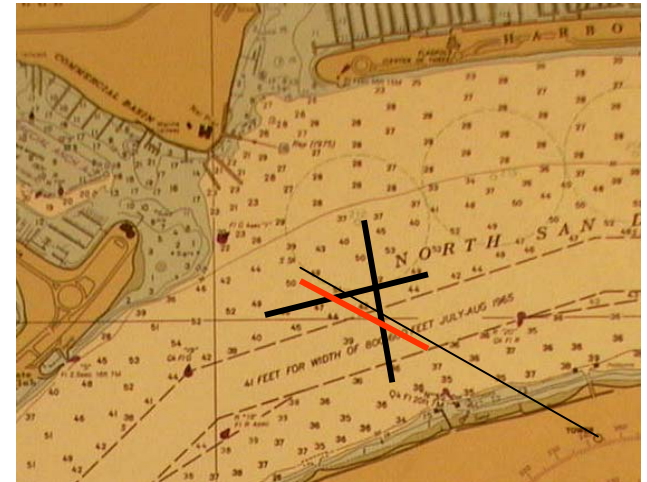

Moving the hoey arm toward the 120 degree mark



In the context of imagining displacement of the third LOP

Visual Imagery

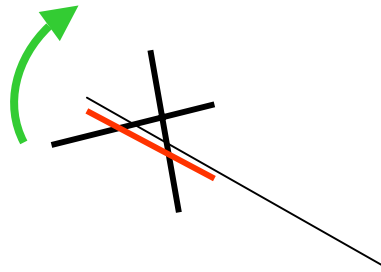

Motor Imagery

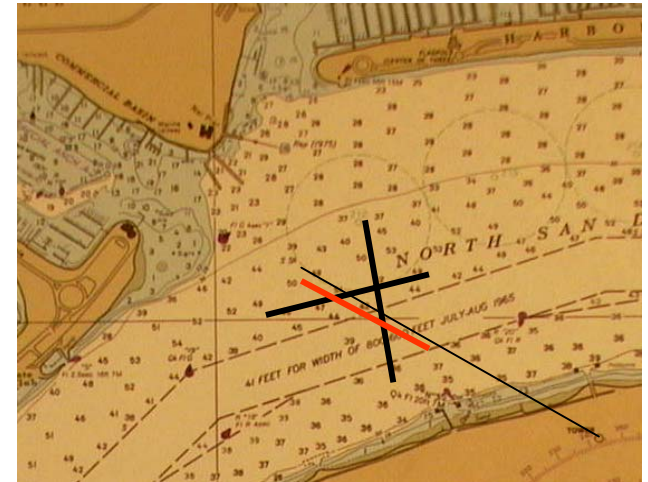

Moving hoey arm to set 120° in the context of imagining a small clockwise displacement

Visual Imagery

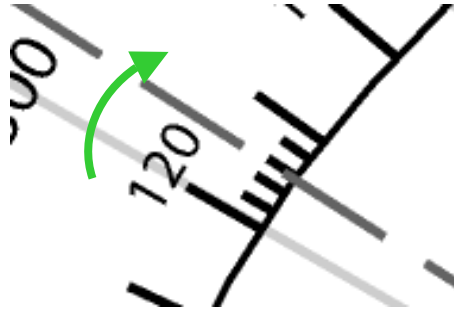

Motor Imagery

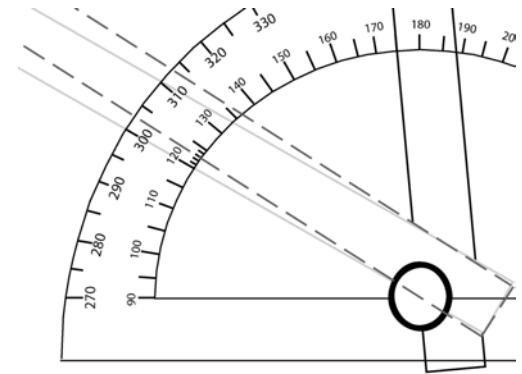
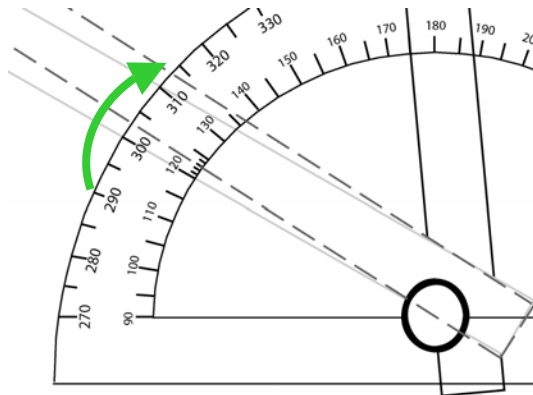

“I know what he’s doing”

Multi-modal Imagination

- Integrated visual and motor imagery of clockwise displacement of hoey arm created in the manipulation of the hoey arm while trying out provisional LOPs
 - Combined with the visual experience of the hoey scale while focusing on the setting of the hoey angle to plot the third LOP
 - Produces a visualization of a numerically larger bearing.
 - Adding a small amount to each bearing is what the missing deviation term would do. This is when the plotter has his insight.
-

Cognitive Implications of Embodied Thinking

- Bodily motion acquires meaning in relation to culturally organized environment
 - Multimodal experiences are integrated wholes
-

In Multi-modal Experiences

- When the content of modes overlaps, the stability of representations is enhanced and reasoning is facilitated.
 - When the content of modes differs in complementary ways, new combinations of content are created and new insights may be “seen”.
-

Discovery of the missing deviation term



Somatosensory anticipation superimposed on visual experience

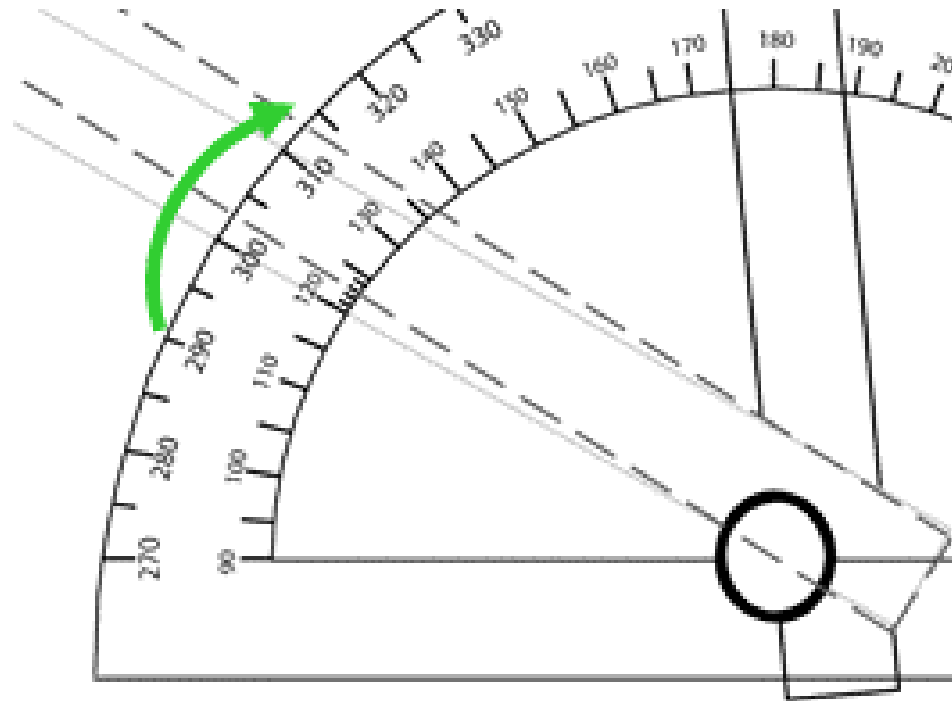

Unit of Analysis

(Triangle of embodied communication)

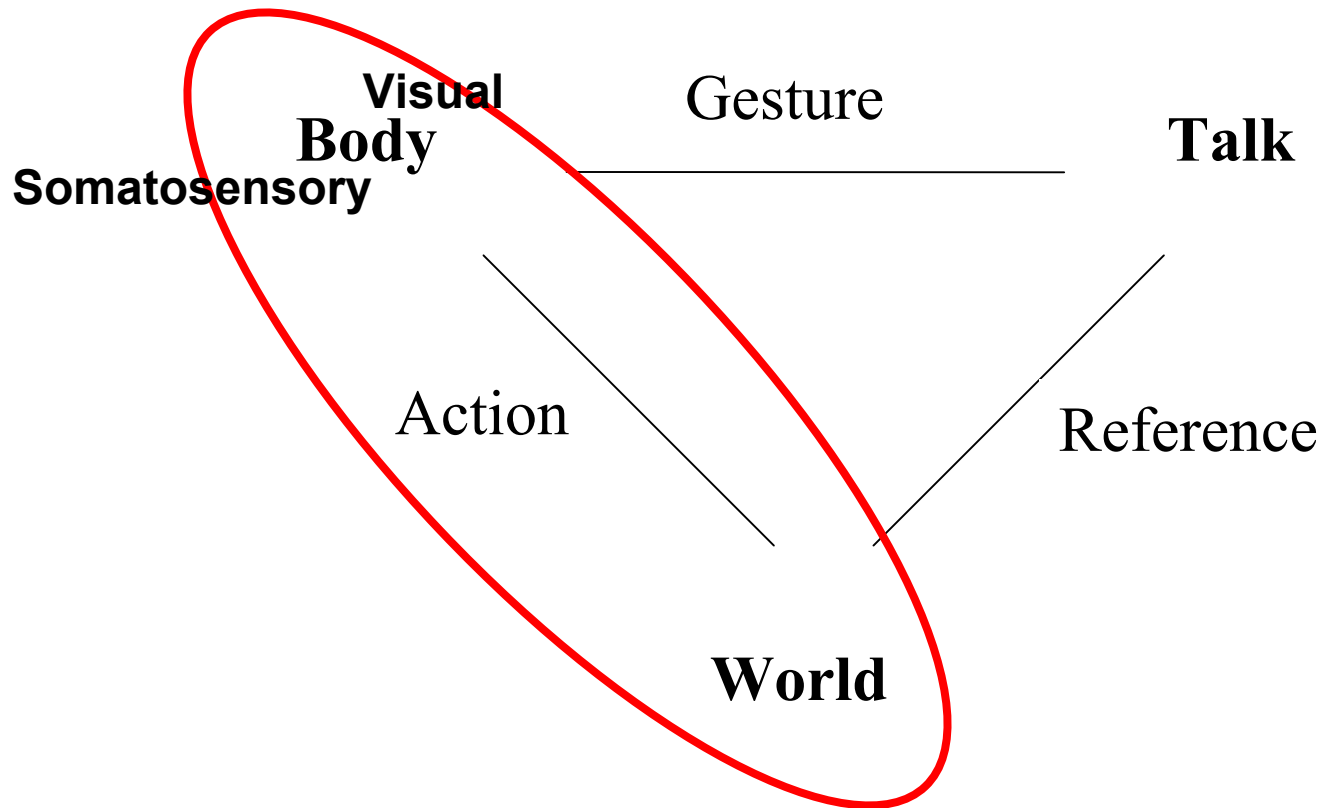

Experiencing the present while imagining the future

Talk primes bodily action.
“one two zero”

Body

Talk

Action in the moment includes
anticipation of the coming moments
with current perceptions

Reference

World

Unit of Analysis

(Square cut gem of interaction)

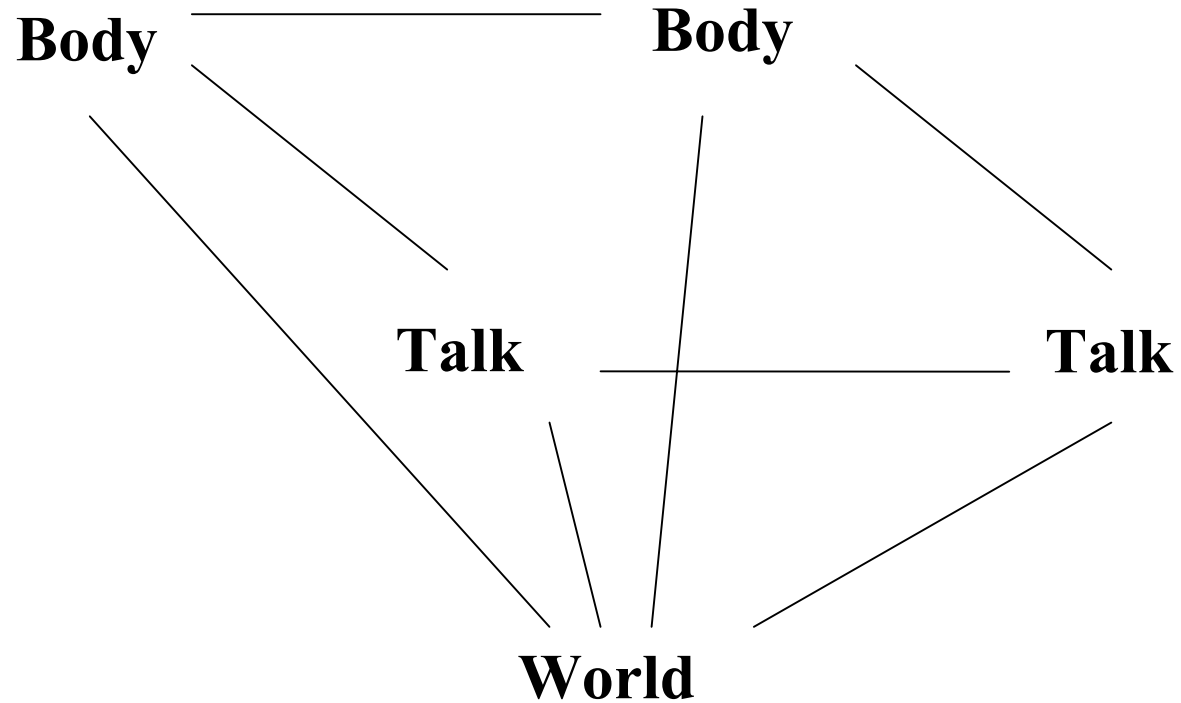

Relations among the contents of modes in multimodal acts of meaning making

■ **Relation**

- Congruent
- Complementary
- Incongruent
- Contradictory

■ **Effect**

- Stability
 - Emergence
 - Failure of integration
 - Satire
-

Complex, coherent, multimodal acts of meaning making

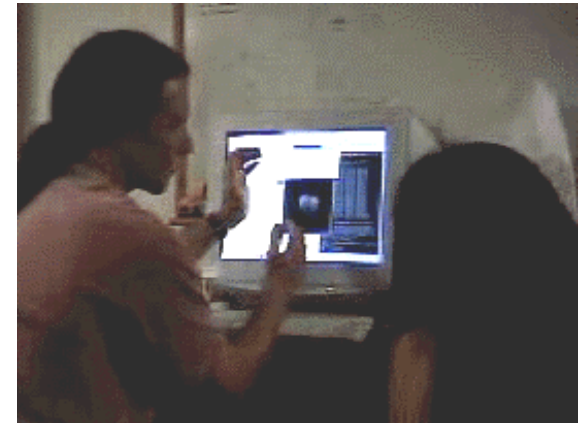

Cognitive Science Changing Direction

In a culturally constructed world of material symbols, courses of action become trains of thought.

This is where high-level cognition is enacted.

Even here, it is not clear that all of the interesting work is done by symbol processes or representations.

What is the brain doing when bodies are in interaction with such social and material environments?

That's a new key question for cognitive science.
